

Formulate 12' Funnel

FUN-03

Formulate™ Funnels transform any environment through form, fabric and lighting. Funnels feature a heavy-duty, wooden base and silver powder coated truss interior to create a dynamic, towering structure that commands attention. Fabric graphics feature a zipper at the top and a silicone edge at the bottom for easy assembly. Accent LED light kits are not included, but can be purchased a la carte to add a glow within the funnel structures.

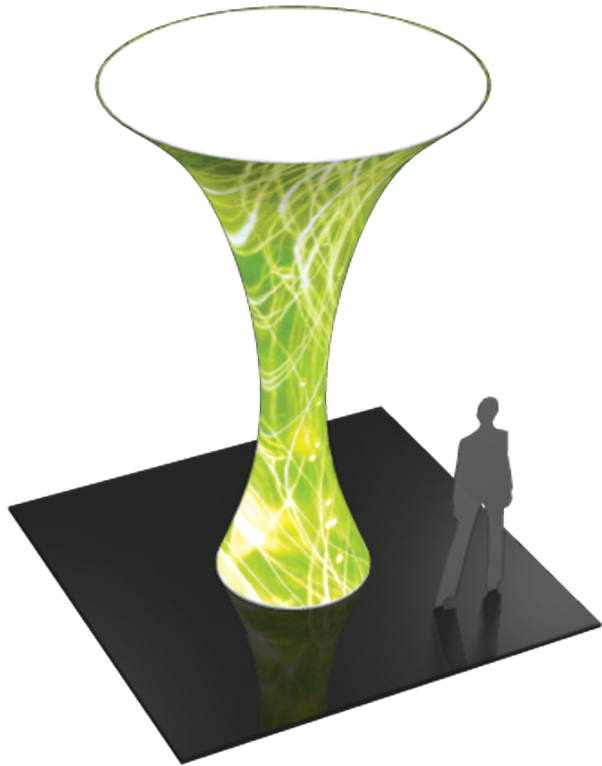

features and benefits:

- State-of-the-art 30mm curved aluminum tube frame with expanding spigots
- Easy to store and ship
- Quick to set up
- Kit includes: one frame, one dye-sublimated zipper pillowcase graphic, and one wheeled molded OCH2 storage case (base packs separately).
- Lifetime hardware warranty against manufacturer defects

dimensions:

Hardware	Graphic
<p>Assembled unit: 140.974" h x 42" dia.(base) x 98.5" dia.(top) 3581mm(h) x 1067mm(dia) x 2502mm(dia)</p> <p>Approximate weight (includes graphic): 96.3 lbs / 43.68 kg</p>	<p>Total visual area: 94.67" w x 155" h, three prints 2405mm(w) x 3937mm(h)</p> <p>Please be sure to include 5" bleed around the perimeter.</p> <p>Refer to related graphic template for more information.</p>
<p>Shipping</p> <p>Shipping dimensions: One OCH2 case: 52" l x 30" w x 15" h 1321mm(l) x 762mm(w) x 381mm(h)</p> <p>Approximate shipping weight (with cases): 126 lbs / 57 kg</p>	<p>Visit: www.exhibitors-handbook.com/graphic-templates</p>

additional information:

Graphic material:
dye-sublimated zipper pillowcase graphic with opaque liner



www.display-setup-animations.com

We are continually improving and modifying our product range and reserve the right to vary the specifications without prior notice. All dimensions and weights quoted are approximate and we accept no responsibility for variance. E&OE. See Graphic Templates for graphic bleed specifications.

Parts Included

Part Label	Qty	Part Code
EXPANDING SPIGOT FOR 30MM TUBE	x12	ES-30
(2) PCS BASE WITH FC RING	x1	FUN-BASE
24" X 24" X 1/4" STEEL BASE PLATE	x2	FUN-PLATE-ST
775MM PH 45 DEG. LOCKS BOTH ENDS	x3	FUN-PH-45
30MM X 916MM SPREADER TUBE WITH PE	x3	FUN-T1
30MM X 5' CURVED TUBE WITH SPREADER	x3	FUN-T2-SP
30MM X 5' CURVED TUBE	x3	FUN-T2
1200MM LENGTH OF TRILOCK TRUSS HUB WITH CHANNELS	x1	FUN-HUB-TRI
1200MM LENGTH OF TRILOK TRUSS	x2	TRI30-1200

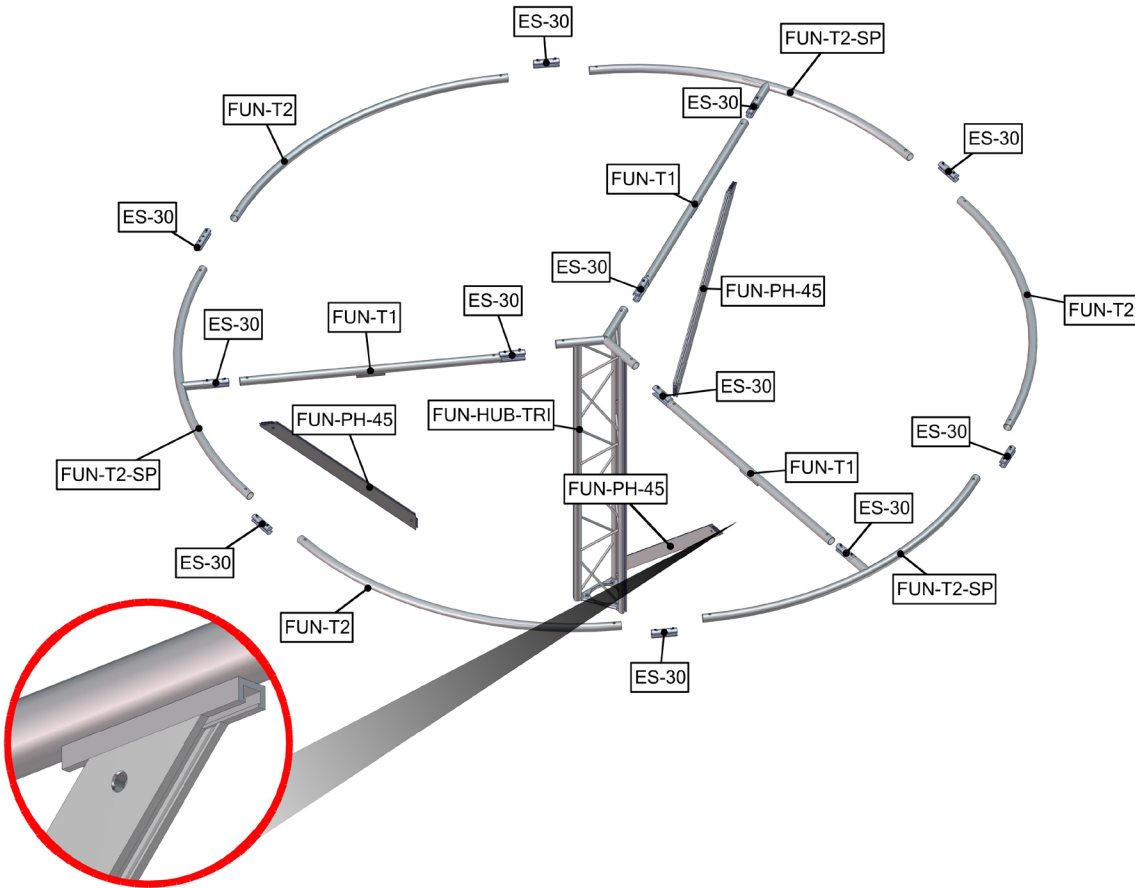
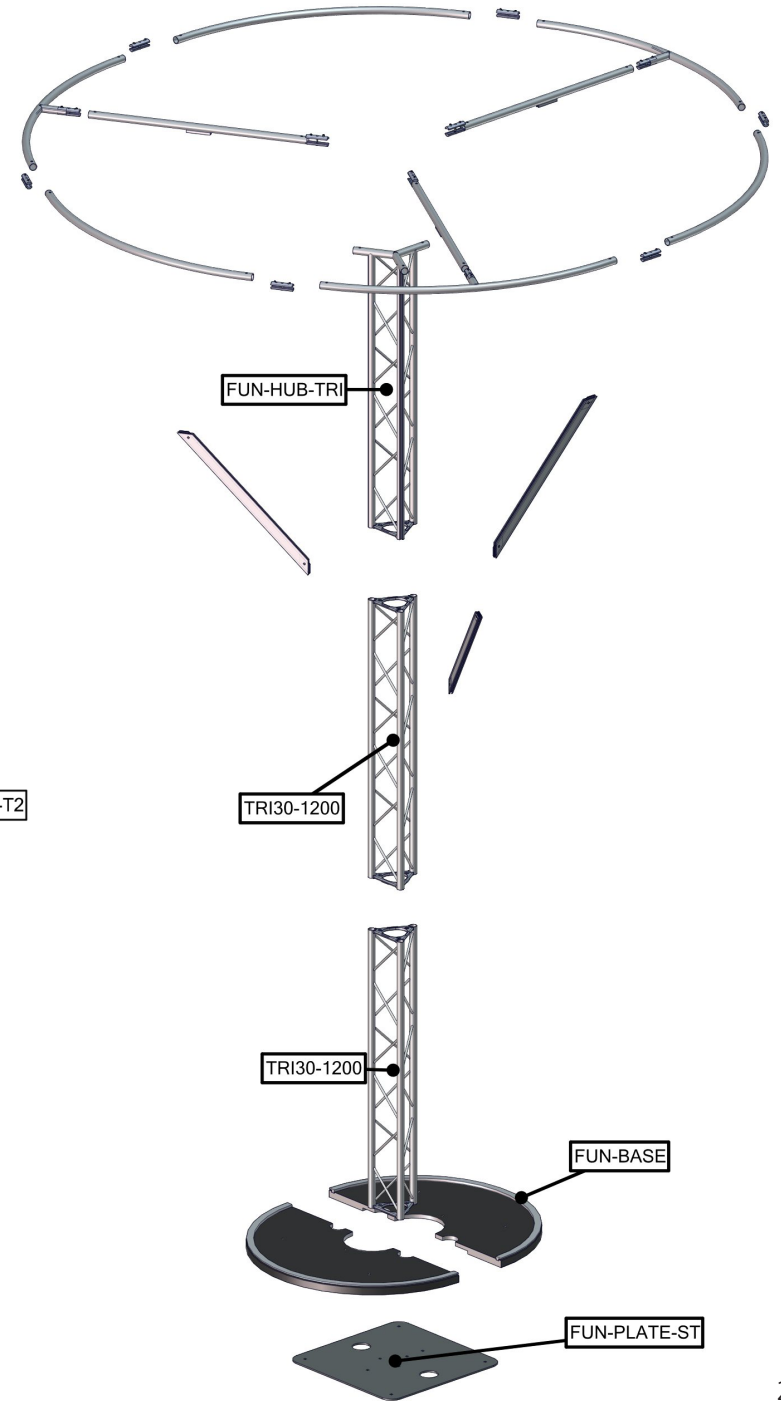

STEP 1: ASSEMBLE FRAME

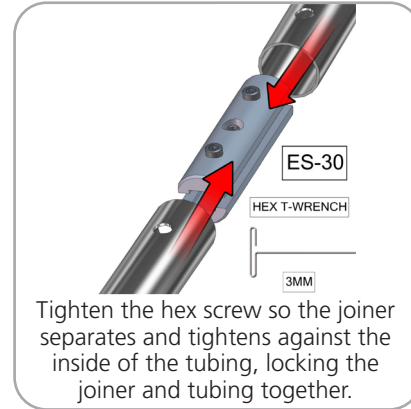
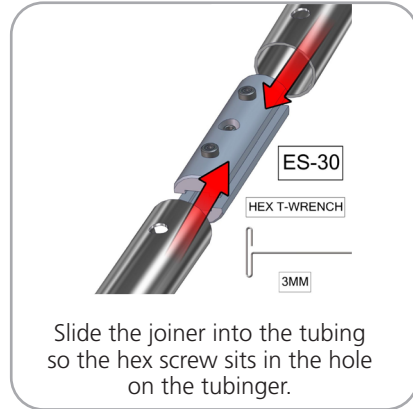
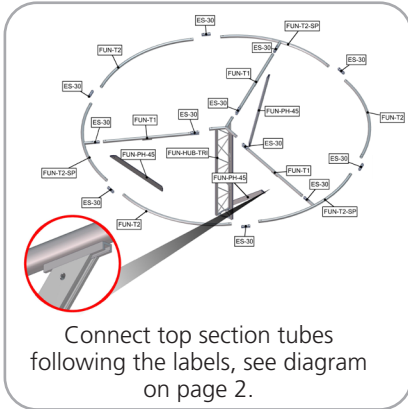

STEP 2: ATTACH BASE

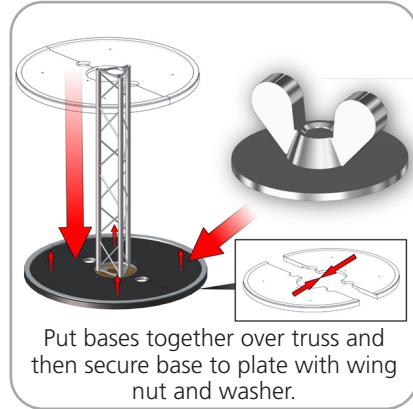
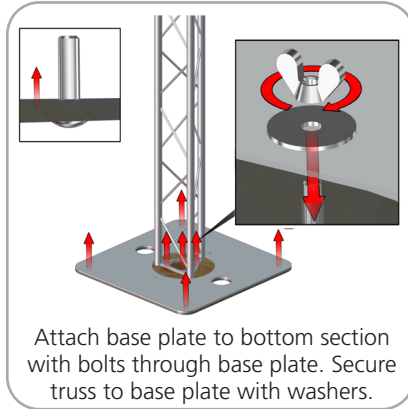

STEP 3: ATTACH GRAPHIC

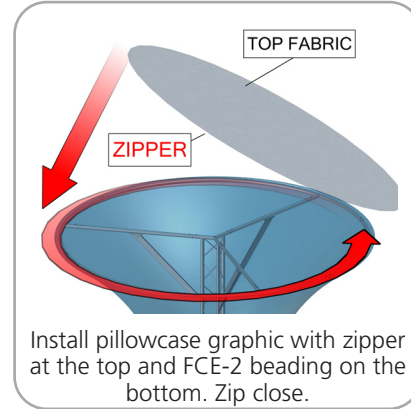

STEP 4: ATTACH TRUSS

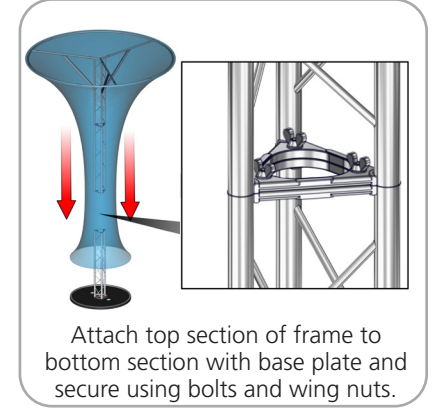

STEP 5: ATTACH GRAPHIC

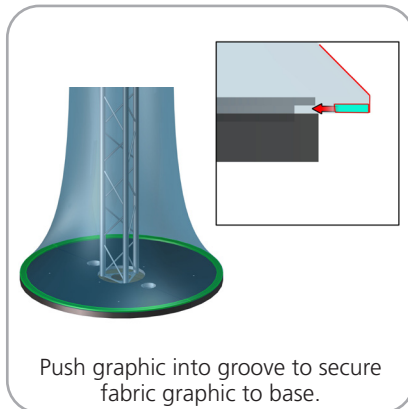

Check out these related products:

The Formulate line is a collection of stylish, ergonomically designed tabletop, 8ft, 10ft, 20ft exhibits, hanging structures, and display accessories. Formulate combines state-of-the-art zipper pillowcase dye-sublimated fabric coverings with a premium lightweight aluminum structure. Formulate is efficient, easy to assemble and disassemble, and offers remarkable style options and choices.

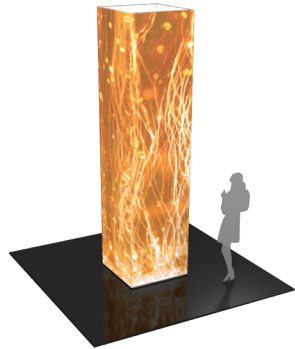

Formulate 20ft Column

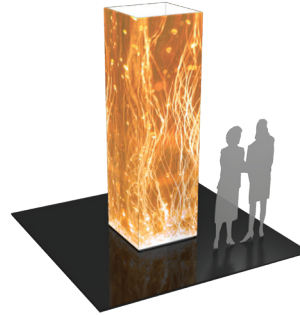

Formulate 10ft Column

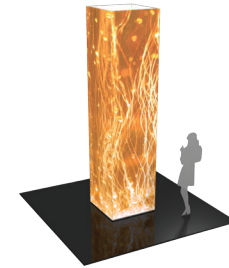

Formulate 8ft Column

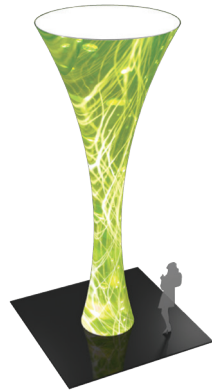

Formulate 20ft Funnel

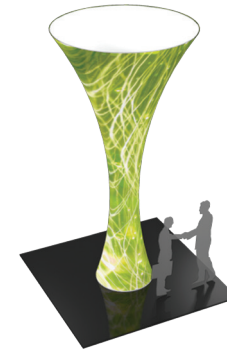

Formulate 16ft Funnel

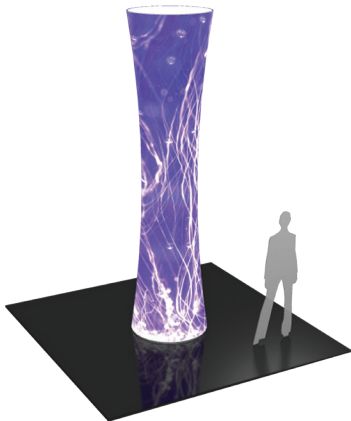

Formulate 12ft Cylinder

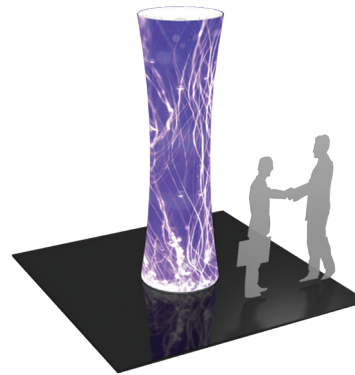

Formulate 10ft Cylinder

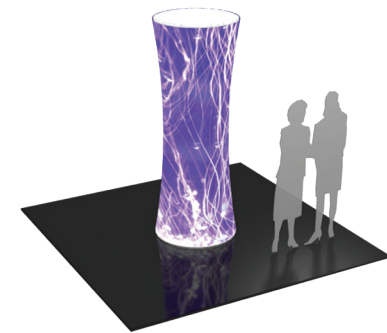

Formulate 8ft Cylinder